

Round 2 さかさま

満点：600点
 最高点：550点
 平均点：253.8点

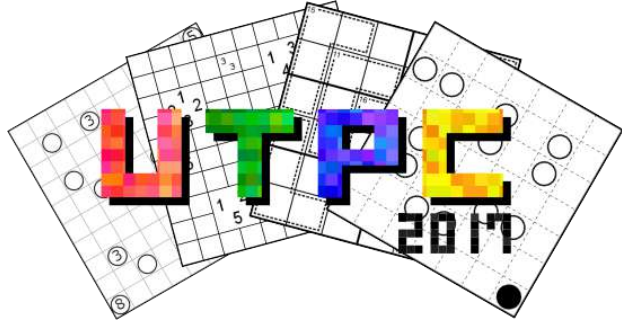

1. 四角に切れ

① 20点 作●しもりん

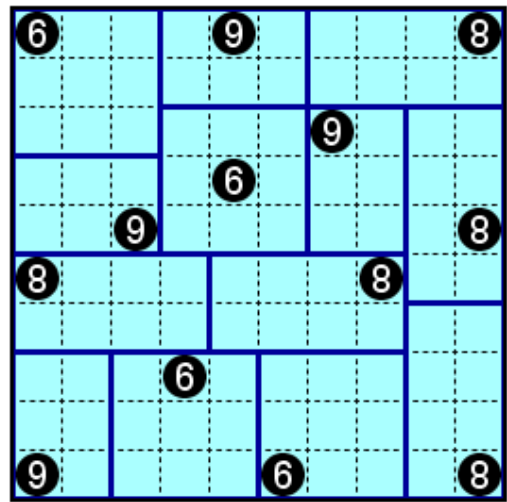
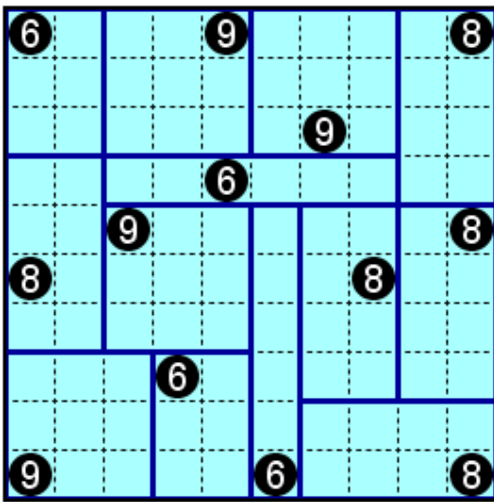

② 20点 作●しもりん

2. Tapa・Pata

① 15点 作●初月葉桜

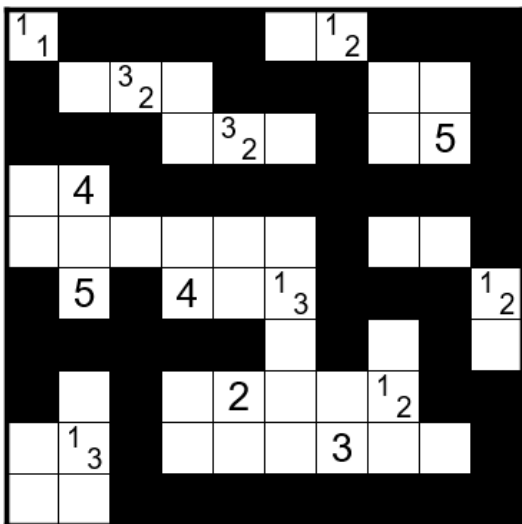

② 25点 作●初月葉桜

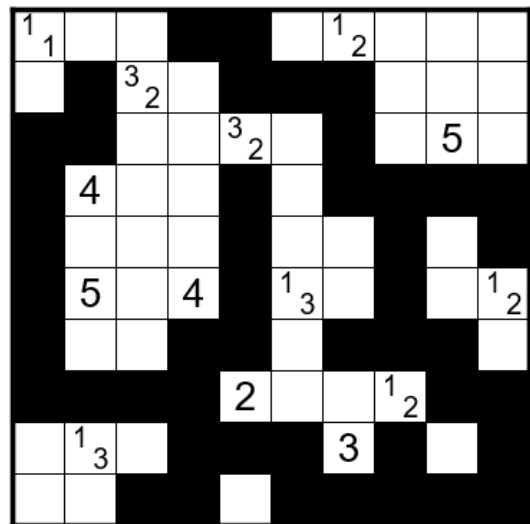

3. ましゅ

① 10点 作●しもりん

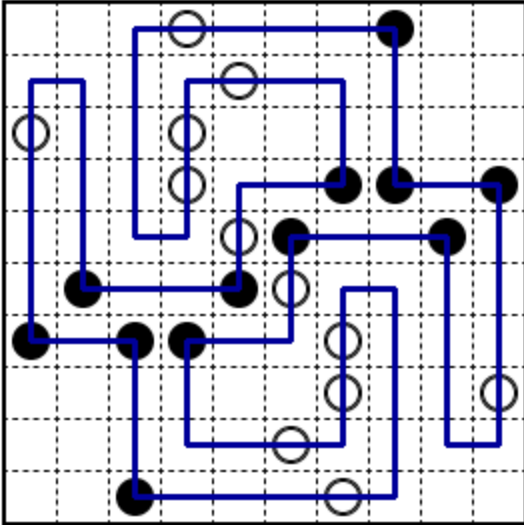

② 10点 作●しもりん

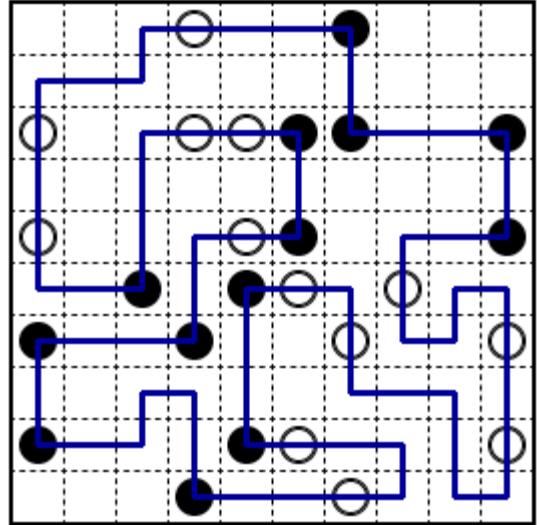

4. リバースましゅ

① 30点 作●panista

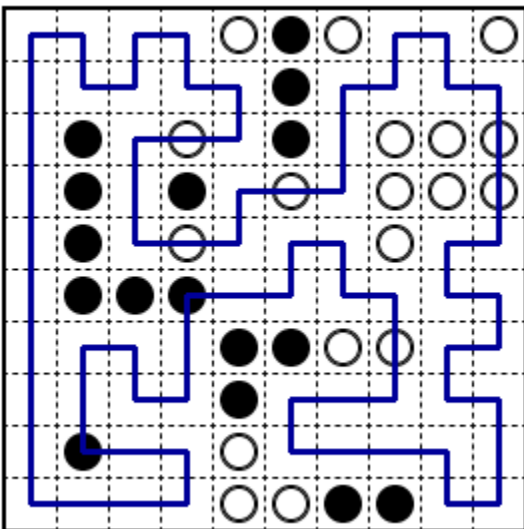

② 30点 作●panista

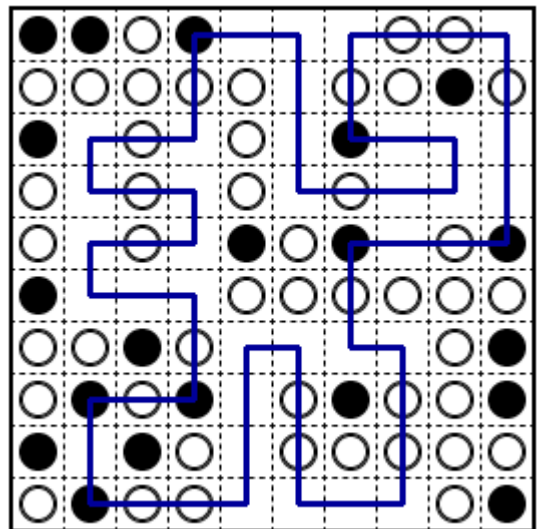

5. 間違い探し

① 40点 作●panista

A1, B9, F5, G6, H2, H13, I15, J14, M8, N3



6. 白丸黒丸白

① 25点 作●SP1

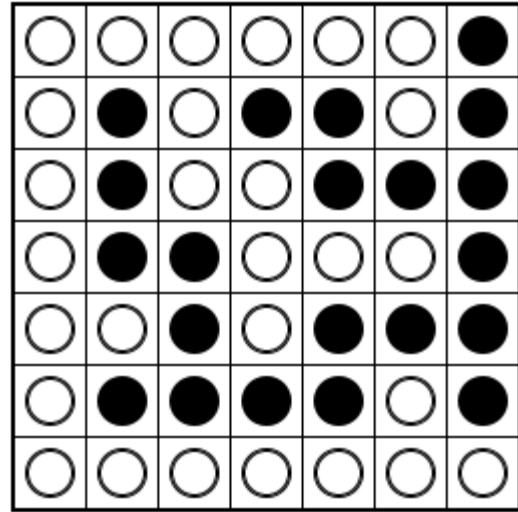

② 25点 作●SP1

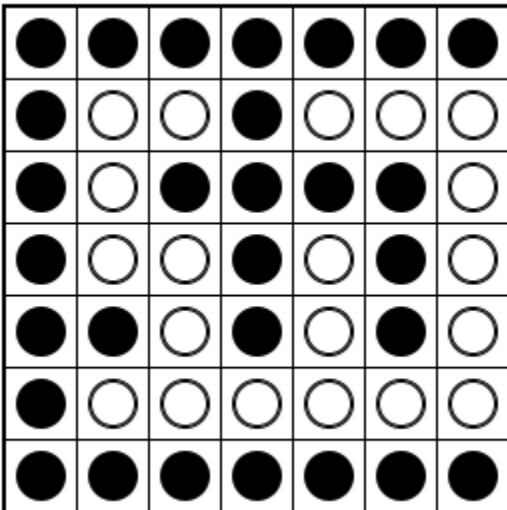

③ 80点 作●SP1

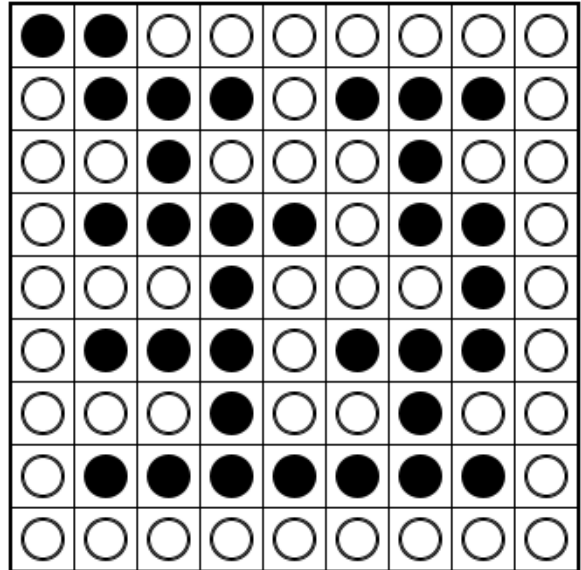

7. ウィンドウサングラス

① 50点 作●panista

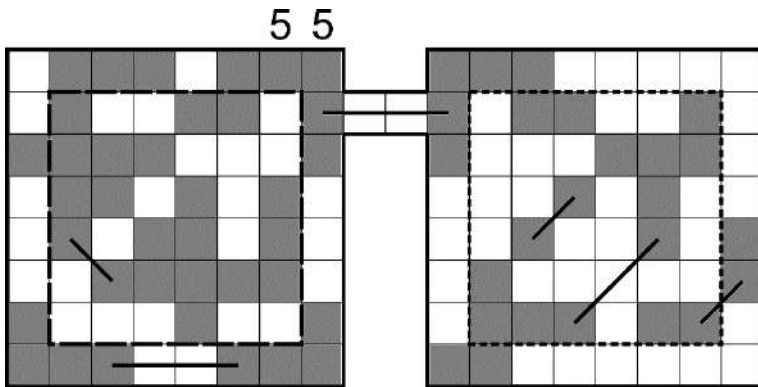

② 80点 作●panista

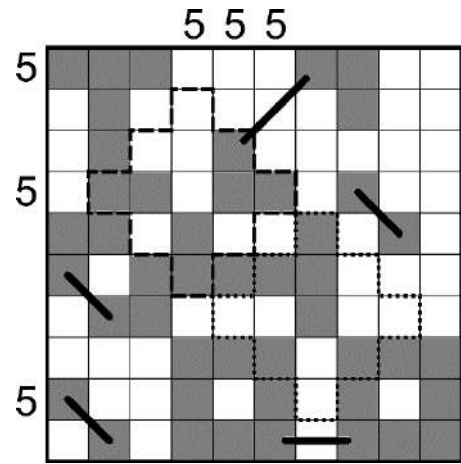

8. Hayeweka

① 50点 作●panista

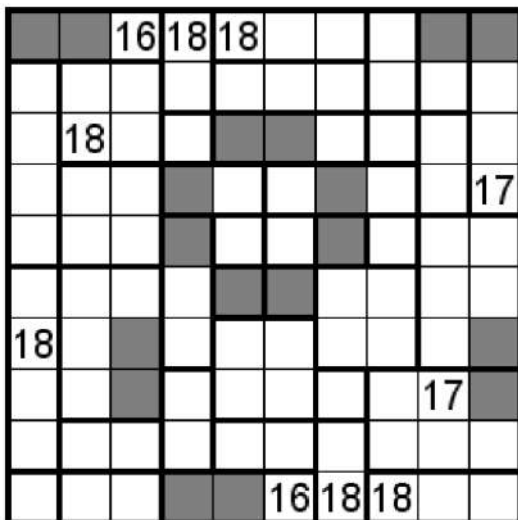

② 90点 作●panista

